

Elite @Home

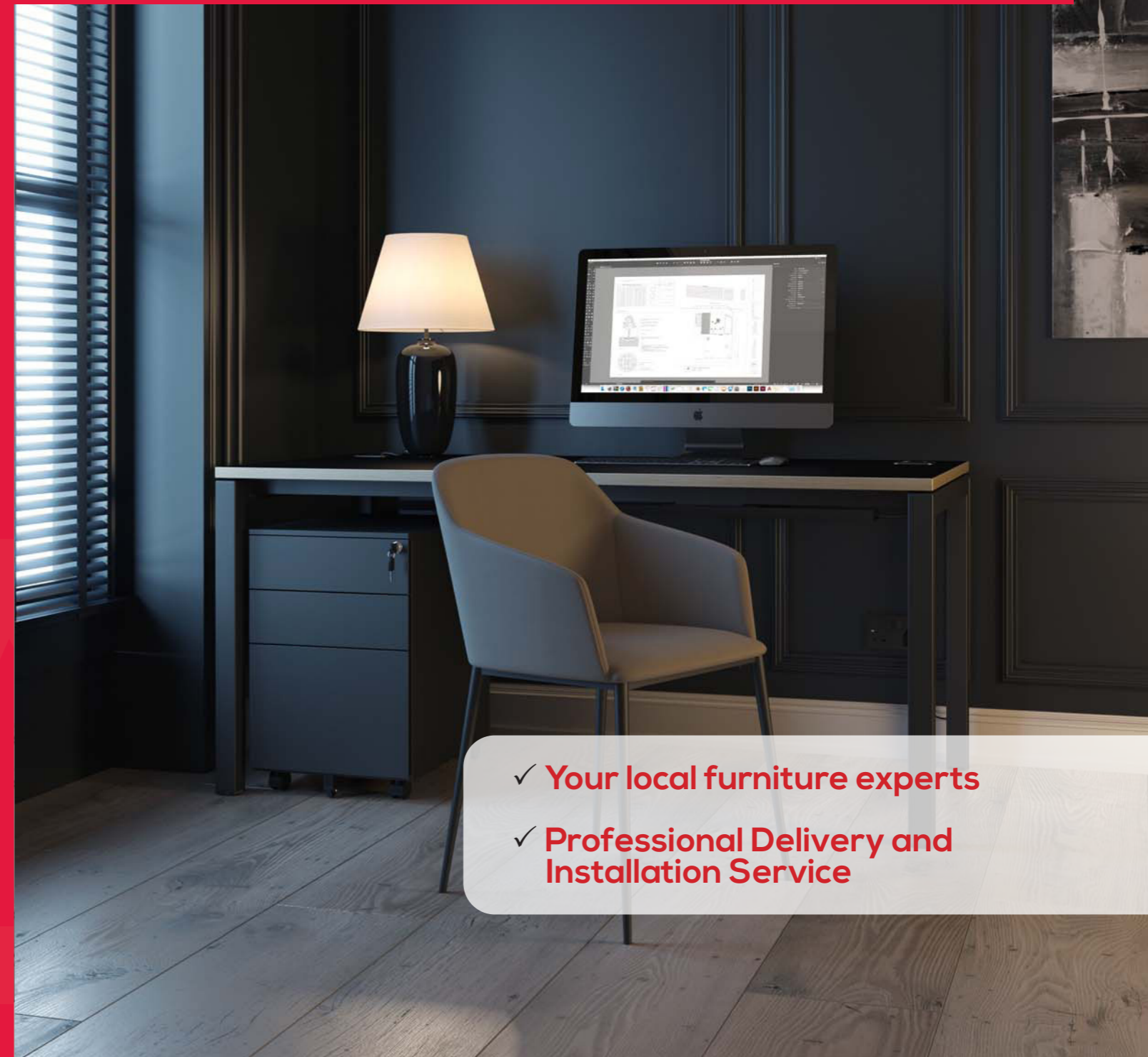

- ✓ **Your local furniture experts**
- ✓ **Professional Delivery and Installation Service**

☎ 0333 344 4987
✉ sales@taavetti.co.uk
www.taavetti.co.uk



For all Enquiries please
telephone **0333 344 4987** or email **sales@taavetti.co.uk**

www.taavetti.co.uk

Contents

Desking



Progress Plus 3



Lux 5



Reflex 7



Matrix Height Settable 9



Matrix Fixed Height 11



Kassini 13



Windsor 15

Storage



Pedestals 39



Steel Pedestals 41



Low Storage Units 43



Bookcases 45



Tall Storage Units 47

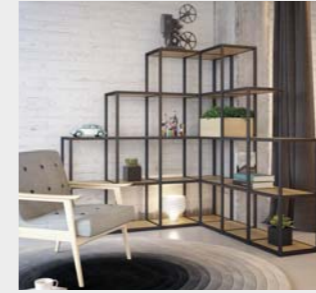

Cubeform 49



Handles 53

Seating



Venice 17



Enna 19



i-sit 21



Breeze 23



Tempo 25



Loop 27



Vida 29



Ace 31



Pablo 33



Norden 35



Luma 37

Accessories



Power Modules 55



Monitor Arms 57



Lighting 59



Finishes 61

Progress Plus Sit / Stand Desk

Key Features

- 25mm Top Panel available in MFC, MDF or Veneer.
 - MFC:** Ash, Autumn Cherry, Beech, Chester Oak, English Walnut, Grey, Grey Nebraska Oak, Laurentii Wenge, Natural Nebraska Oak and White.
 - MDF:** Black Matt Nanotech surface finish.
 - Veneer:** Oak and Walnut.
- Metalwork available in Silver RAL 9006 (standard), Black Graphite RAL 9004 and White RAL 9003.
- Cable ports supplied in Silver (standard), Black or White.
- Sit / stand height adjustment of 650mm-1280mm via electronic up / down keypad.
- Complete with horizontal cable tray.
- Advanced electronic keypad available with IOS and Android mobile / tablet app available.



Progress Plus Rectangular Desk

		Retail MFC	Retail Veneer
PPR18/8 EHA	1800w x 800d x 650-1280h.	£1,189	£1,446
PPR16/8 EHA	1600w x 800d x 650-1280h.	£1,166	£1,422
PPR14/8 EHA	1400w x 800d x 650-1280h.	£1,142	£1,399
PPR12/8 EHA	1200w x 800d x 650-1280h.	£1,119	£1,375



Track Cable Riser

		Retail Price
TCR/SB	Silver / Black.	£72
TCR/BB	Black / Black.	£72
TCR/WB	White / Black.	£72



Progress Plus Advanced Keypad

		Retail Price
/PPKP	Advanced keypad. Upgrade at point of purchase. 3 Programmable memory buttons.	£35



Progress Plus Advanced Keypad App Dongle

		Retail Price
PPKPD	Progress Plus advanced keypad required for this product. For use with a mobile application. Android and IOS App provides access to a healthy working programme.	£48



Ace Chair: Page 31

Lux Desk

Key Features

- 25mm Top Panel available in MFC, MDF or Veneer.
 - MFC:** Ash, Autumn Cherry, Beech, Chester Oak, English Walnut, Grey, Grey Nebraska Oak, Laurentii Wenge, Natural Nebraska Oak and White.
 - MDF:** Black Matt Nanotech surface finish.
 - Veneer:** Oak and Walnut.
- Metalwork available in Silver RAL 9006 (standard), Black Graphite RAL 9004 and White RAL 9003.
- Timber leg frames available in Ash (standard), Stained Walnut (add £42), Stained Espresso (add £50), Stained Wenge (add £50), Stained Black (add £50) and White (add £66).
- Cable ports supplied in Silver (standard), Black or White.



Lux Rectangular Desk

		Retail MFC	Retail Veneer
LUXD20/10	2000w x 1000d x 740h.	£1,489	£1,787
LUXD18/10	1800w x 1000d x 740h.	£1,366	£1,638
LUXD16/10	1600w x 1000d x 740h.	£1,243	£1,491
LUXD14/10	1400w x 1000d x 740h.	£1,189	£1,427
LUXD12/10	1200w x 1000d x 740h.	£1,133	£1,360
LUXD10/10	1000w x 1000d x 740h.	£1,077	£1,293
LUXD20/8	2000w x 800d x 740h.	£1,435	£1,722
LUXD18/8	1800w x 800d x 740h.	£1,312	£1,573
LUXD16/8	1600w x 800d x 740h.	£1,189	£1,426
LUXD14/8	1400w x 800d x 740h.	£1,135	£1,362
LUXD12/8	1200w x 800d x 740h.	£1,079	£1,295
LUXD10/8	1000w x 800d x 740h.	£1,023	£1,228
LUXD20/6	2000w x 600d x 740h.	£1,381	£1,657
LUXD18/6	1800w x 600d x 740h.	£1,258	£1,508
LUXD16/6	1600w x 600d x 740h.	£1,135	£1,361
LUXD14/6	1400w x 600d x 740h.	£1,081	£1,297
LUXD12/6	1200w x 600d x 740h.	£1,025	£1,230
LUXD10/6	1000w x 600d x 740h.	£969	£1,163

Lux Cable Tray

If a pedestal is required when the cable tray is selected use the Low Mobile Pedestal or the Low Mobile Pedestal on Castors.



		Retail Metalwork
LCTR20	For 2000w Workstations (1500w).	£105
LCTR18	For 1800w Workstations (1300w).	£98
LCTR16	For 1600w Workstations (1100w).	£91
LCTR14	For 1400w Workstations (900w).	£80
LCTR12	For 1200w Workstations (700w).	£68
LCTR10	For 1000w Workstations (500w).	£54

Wooden Frame Finishes

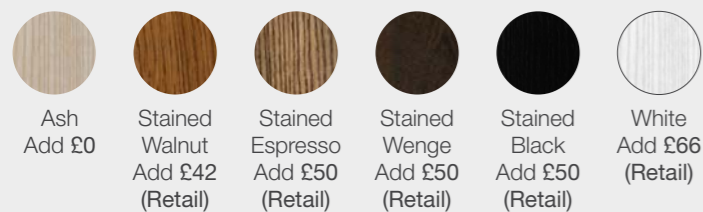

Enna Chair: Page 19

Reflex Desk

Key Features

- 25mm Top Panel available in MFC, MDF or Veneer.
 - MFC:** Ash, Autumn Cherry, Beech, Chester Oak, English Walnut, Grey, Grey Nebraska Oak, Laurentii Wenge, Natural Nebraska Oak and White.
 - MDF:** Black Matt Nanotech surface finish.
 - Veneer:** Oak and Walnut.
- Metalwork available in Silver RAL 9006 (standard), Black Graphite RAL 9004, White RAL 9003, Chrome Effect (Add **15%**) and Raw Finish (Add **5%**).
- Cable ports supplied in Silver (standard), Black or White.



Reflex Rectangular Desk

		Retail MFC	Retail Veneer
RR20/10	2000w x 1000d x 740h.	£881	£1,321
RR18/10	1800w x 1000d x 740h.	£864	£1,295
RR16/10	1600w x 1000d x 740h.	£846	£1,270
RR20/8	2000w x 800d x 740h.	£864	£1,295
RR18/8	1800w x 800d x 740h.	£846	£1,270
RR16/8	1600w x 800d x 740h.	£828	£1,243



Reflex Cable Tray

If a pedestal is required when the cable tray is selected specify the Low Mobile Pedestal or the Low Mobile Pedestal on Castors.

		Retail Metalwork
RCT20	For 2000w Workstations (1410w).	£137
RCT18	For 1800w Workstations (1210w).	£123
RCT16	For 1600w Workstations (1010w).	£109



Reflex Cable Riser

		Retail Metalwork
RCR	Can be retrofitted. Capacity to vertical enclose 1 x 12mm diameter power cable.	£78

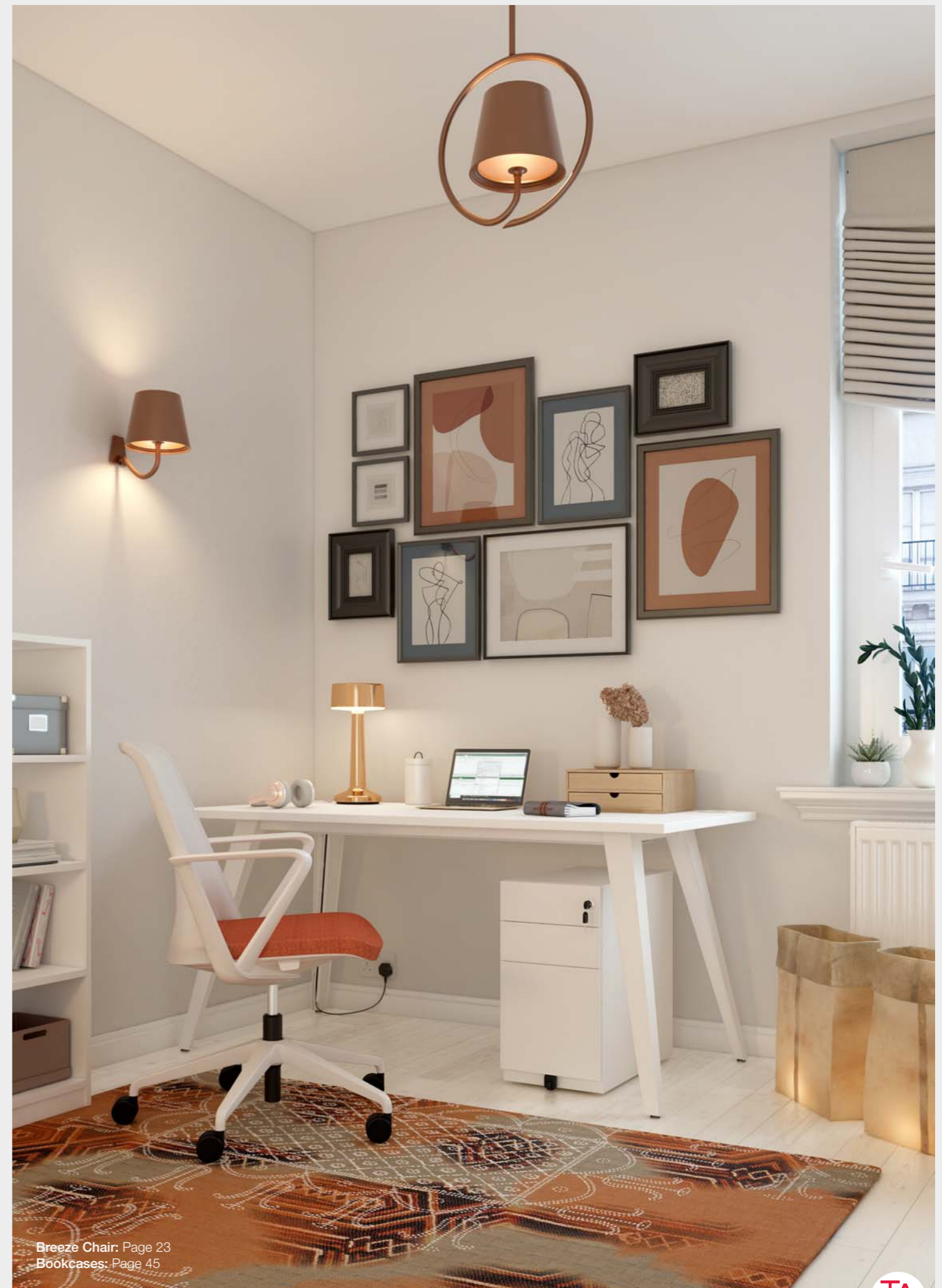

Breeze Chair: Page 23
Bookcases: Page 45

Matrix Height Settable Desk

Key Features

- 25mm Top Panel available in MFC or MDF.
- **MFC:** Ash, Autumn Cherry, Beech, Chester Oak, English Walnut, Grey, Grey Nebraska Oak, Laurentii Wenge, Natural Nebraska Oak and White.
- **MDF:** Black Matt Nanotech surface finish.
- Metalwork available in Silver RAL 9006 (standard), Black Graphite RAL 9004, White RAL 9003, Chrome Effect (Add **15%**) and Raw Finish (Add **5%**).
- Cable ports supplied in Silver (standard), Black or White.
- Height settable between 650mm - 850mm high.
- Sit / sit height adjustment via single leg fixing.



Matrix Height Settable Rectangular Desk

		Retail MFC
AR20/10	2000w x 1000d x 650-850h.	£608
AR18/10	1800w x 1000d x 650-850h.	£594
AR16/10	1600w x 1000d x 650-850h.	£585
AR14/10	1400w x 1000d x 650-850h.	£576
AR12/10	1200w x 1000d x 650-850h.	£563
AR20/8	2000w x 800d x 650-850h.	£595
AR18/8	1800w x 800d x 650-850h.	£587
AR16/8	1600w x 800d x 650-850h.	£577
AR14/8	1400w x 800d x 650-850h.	£562
AR12/8	1200w x 800d x 650-850h.	£553
AR10/8	1000w x 800d x 650-850h.	£541
AR20/6	2000w x 600d x 650-850h.	£588
AR18/6	1800w x 600d x 650-850h.	£579
AR16/6	1600w x 600d x 650-850h.	£568
AR14/6	1400w x 600d x 650-850h.	£559
AR12/6	1200w x 600d x 650-850h.	£551
AR10/6	1000w x 600d x 650-850h.	£540

Matrix Cable Tray

When the cable tray is selected the Narrow Mobile Pedestal and the Mobile Pedestal will protrude the desk, as an alternative specify the Low Mobile Pedestal or the Low Mobile Pedestal on Castors.



		Retail Metalwork
MA10	For 2000w Workstations (1600w).	£61
MA9	For 1800w Workstations (1400w).	£56
MA7	For 1600w Workstations (1200w).	£48
MA5	For 1400w Workstations (1000w).	£46
MA3	For 1200w Workstations (800w).	£43
MA2	For 1000w Workstations (600w).	£38

Matrix Cable Riser

		Retail Metalwork
ALCR	2 Per Pack.	£37



Ace Chair: Page 31
Cubeform: Page 49

Matrix Desk

Key Features

- 25mm Top Panel available in MFC or MDF.
- **MFC:** Ash, Autumn Cherry, Beech, Chester Oak, English Walnut, Grey, Grey Nebraska Oak, Laurentii Wenge, Natural Nebraska Oak and White.
- **MDF:** Black Matt Nanotech surface finish.
- Metalwork available in Silver RAL 9006 (standard), Black Graphite RAL 9004, White RAL 9003, Chrome Effect (Add **15%**) and Raw Finish (Add **5%**).
- Cable ports supplied in Silver (standard), Black or White.



Matrix Rectangular Desk

		Retail MFC
MR20/8	2000w x 800d x 740h.	£466
MR18/8	1800w x 800d x 740h.	£458
MR16/8	1600w x 800d x 740h.	£453
MR14/8	1400w x 800d x 740h.	£447
MR12/8	1200w x 800d x 740h.	£441
MR10/8	1000w x 800d x 740h.	£435
MR20/7	2000w x 700d x 740h.	£462
MR18/7	1800w x 700d x 740h.	£456
MR16/7	1600w x 700d x 740h.	£450
MR14/7	1400w x 700d x 740h.	£445
MR12/7	1200w x 700d x 740h.	£438
MR10/7	1000w x 700d x 740h.	£433
MR20/6	2000w x 600d x 740h.	£458
MR18/6	1800w x 600d x 740h.	£453
MR16/6	1600w x 600d x 740h.	£447
MR14/6	1400w x 600d x 740h.	£441
MR12/6	1200w x 600d x 740h.	£435
MR10/6	1000w x 600d x 740h.	£430

Matrix Cable Tray

When the cable tray is selected the Narrow Mobile Pedestal and the Mobile Pedestal will protrude the desk, as an alternative specify the Low Mobile Pedestal or the Low Mobile Pedestal on Castors.



		Retail Metalwork
MA10	For 2000w Workstations (1600w).	£61
MA9	For 1800w Workstations (1400w).	£56
MA7	For 1600w Workstations (1200w).	£48
MA5	For 1400w Workstations (1000w).	£46
MA3	For 1200w Workstations (800w).	£43
MA2	For 1000w Workstations (600w).	£38

Matrix Cable Riser

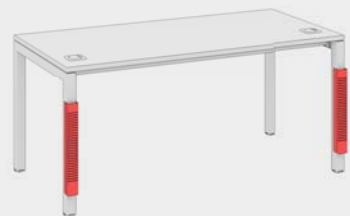

		Retail Metalwork
MLCR	2 Per Pack.	£32



Ace Chair: Page 31
 Pedestals: Page 39
 Steel Pedestals: Page 41
 Cubeform: Page 49

Kassini Desk

Key Features

- 25mm Top Panel available in MFC, MDF or Veneer.
 - MFC:** Ash, Autumn Cherry, Beech, Chester Oak, English Walnut, Grey, Grey Nebraska Oak, Laurentii Wenge, Natural Nebraska Oak and White.
 - MDF:** Black Matt Nanotech surface finish.
 - Veneer:** Oak and Walnut.
- Metalwork available in Silver RAL 9006 (standard), Black Graphite RAL 9004, White RAL 9003 and Chrome Effect (Add **15%**).
- Horizontal and vertical wire management as standard.
- Cable ports supplied in Silver (standard), Black or White.



Kassini Rectangular Desk

		Retail MFC	Retail Veneer
KR18	1800w x 800d x 740h.	£556	£800
KR16	1600w x 800d x 740h.	£531	£770
KR14	1400w x 800d x 740h.	£520	£748
KR12	1200w x 800d x 740h.	£500	£726
KR10	1000w x 800d x 740h.	£480	£695
KR8	800w x 800d x 740h.	£441	£632
Under desk mobile pedestals will protrude when specified with a 600mm deep desk.			
KR18/6	1800w x 600d x 740h.	£531	£770
KR16/6	1600w x 600d x 740h.	£522	£753
KR14/6	1400w x 600d x 740h.	£505	£730
KR12/6	1200w x 600d x 740h.	£490	£708
KR10/6	1000w x 600d x 740h.	£473	£681
KR8/6	800w x 600d x 740h.	£437	£624



Tempo Chair: Page 25
 Pedestals: Page 39
 Low Storage: Page 43

Windsor Desk

Key Features

- 25mm Top Panel available in MFC, MDF or Veneer.
 - MFC:** Ash, Autumn Cherry, Beech, Chester Oak, English Walnut, Grey, Grey Nebraska Oak, Laurentii Wenge, Natural Nebraska Oak and White.
 - MDF:** Black Matt Nanotech surface finish.
 - Veneer:** Oak and Walnut.
- Metalwork available in Silver RAL 9006
- Cable ports supplied in Silver (standard), Black or White.

Windsor Rectangular Desk



WR18	1800w x 800d x 740h.
WR16	1600w x 800d x 740h.
WR14	1400w x 800d x 740h.
WR12	1200w x 800d x 740h.
WR10	1000w x 800d x 740h.

Retail MFC	Retail Veneer
£427	£662
£412	£640
£394	£614
£380	£593
£365	£573

Windsor Cable Tray

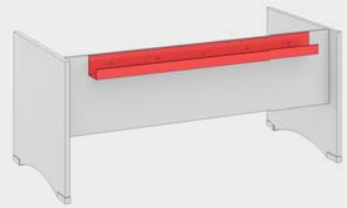

OF11	For 1800w Workstations (1475w).
OF9	For 1600w Workstations (1275w).
OF7	For 1400w Workstations (1075w).
OF5	For 1200w Workstations (900w).
OF2	For 1000w Workstations (670w).

Retail Metalwork
£64
£59
£52
£49
£45



Venice Chair: Page 17
 Steel Pedestals: Page 41
 Low Storage: Page 43

Venice Executive Chair

Key Features

- Fully upholstered leather back and seat.
- Embossed leather.
- Synchronised mechanism with side tension adjustment.
- Seat height adjustment.
- CMHR Foam.
- 700mm Polished aluminium five-star base.
- 65mm twin hard wheeled black castors.



VENHB
Executive High Back
Chair with Castors.
Retail Price £939



VEN
Executive Medium Back
Chair with Castors.
Retail Price £881

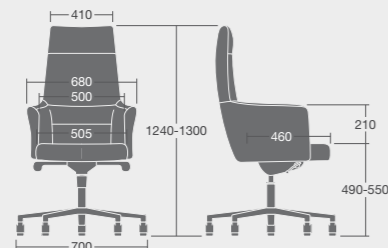

VENHB: Overall Dimensions: 700w x 700d x 1300h

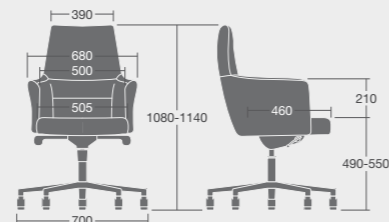

VEN: Overall Dimensions: 700w x 700d x 1140h



Enna Executive Chair

Key Features

- Ribbed soft black leather upholstery.
- Knee tilt mechanism.
- Body weight tension adjustment.
- Seat height adjustment.
- 680mm Polished aluminium five-star base.
- 50mm Twin hard wheeled black castor with chrome hood or protective glides.
- Fixed arms.



ENNHB
Executive High Back
Chair with Castors.
Retail Price £689



ENN
Executive Medium Back
Chair with Castors.
Retail Price £626



ENN/G
Executive Medium Back
Chair with Glides.
Retail Price £641

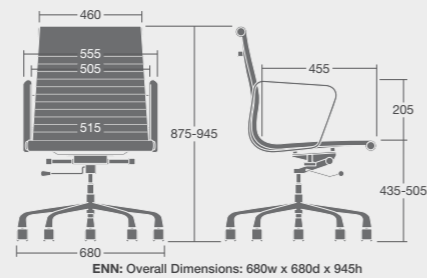
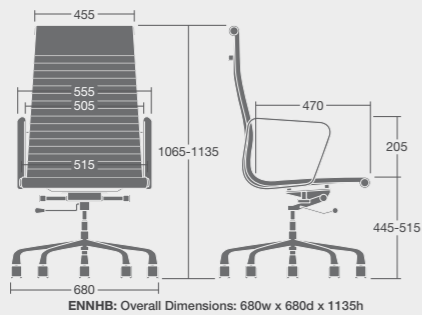

Key Features

- Designed by Ralf Umland.
- Award winning 24/7 task chair.
- Upholstered or mesh back rest.
- Height adjustable back rest (8 positions).
- Rapid back tension adjustment.
- Lockable back angle (3 positions).
- Depth adjustable lumbar support.
- Ergonomic synchronous mechanism.
- Forward dynamic tilt (3° or 6° setting).
- 60mm sliding seat depth adjustment.
- Seat height adjustment.
- CMHR moulded foam.
- 710mm Black nylon 5-star base as standard.
- 60mm load controlled black castors as standard.
- Headrest options available.
- Choice of 4 arm options available.
- Cantilever chair options available.
- 4 Legged chair options available.



ISIT
Upholstered Task Chair without Arms.
Polished Aluminium 5 Star Base.
Retail Price £600



ISIT/PB/4D2
Upholstered Task Chair with Arms.
Polished Aluminium 5 Star Base.
Retail Price £827



ISITM/PB/4D2
Mesh Back Task Chair with Arms.
Polished Aluminium 5 Star Base.
Retail Price £827

- Black Nylon (Standard)
 - Polished Aluminium Add £57 (Retail)
- 5 Star Base Finishes.



ISITC/CA
Upholstered Meeting Chair with Arms.
Black Cantilever Frame.
Retail Price £341



ISITLM/LA
Mesh Back Meeting Chair with Arms.
Black 4 Legged Frame.
Retail Price £351

- Black (Standard)
 - Silver Add £0
 - Black Graphite Add £0
 - Chrome Add £46 (Retail)
- 4 Legged and Cantilever Frame Finishes.

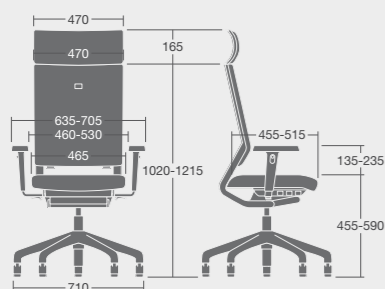

ISIT/UH/4D2: Overall Dimensions: 710w x 710d x 1380h

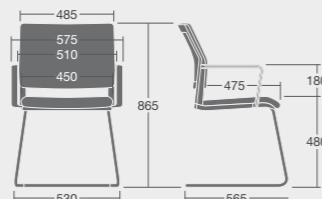

ISITC/CA: Overall Dimensions: 575w x 580d x 865h

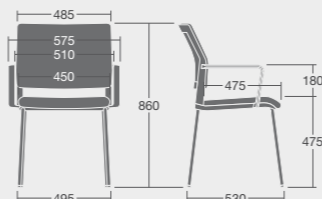

ISITL/LA: Overall Dimensions: 575w x 580d x 860h



Breeze Mesh Back Chair

Key Features

- Designed by Norbert Geelen.
- Breathable mesh back.
- Generous seat pad.
- Integrated height adjustment.
- Central balance point with 12° backward tilt and 5° forward tilt.
- Optional supporting armrests.
- Black nylon or grey nylon five-star base.



BRE/BM
Mesh Back Chair without Arms.
Black Nylon 5 Star Base with
Black Plastic Back.
Retail Price £401



BREG/BM
Mesh Back Chair without Arms.
Grey Nylon 5 Star Base with
Grey Plastic Back.
Retail Price £423



BRE/BM/PA/PB
Mesh Back Chair with Arms.
Polished Aluminium 5 Star Base with
Black Plastic Back.
Retail Price £555

- Black Nylon (Standard)
 - Grey Nylon (Standard)
 - Polished Aluminium Add £53 (Retail)
- 5 Star Base Finishes.



BRE/BM/B4S
Meeting Chair without Arms.
Black 4 Star Base.
Retail Price £467



BRE/BM/PA/P4S
Meeting Chair with Arms.
Polished Aluminium 4 Star Base.
Retail Price £558

- Black Add £66 (Retail)
 - Polished Aluminium Add £56 (Retail)
- 4 Star Base Finishes.

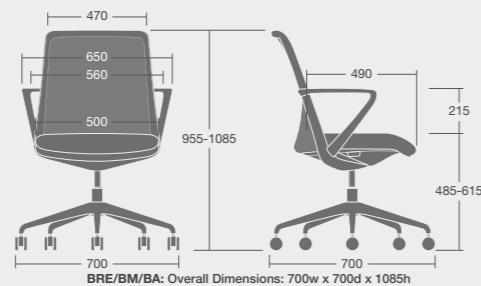

Tempo Mesh Back Chair

Key Features

- Designed by Massimo Costaglia and Giulio Mazzanti.
- Tensile seat mesh.
- Integrated mechanism.
- Fixed supporting armrests.
- Seat height adjustment.
- Black nylon or polished aluminium five-star base.
- Black or polished aluminium four-star base.
- Shell and chair mesh options as below for four-star base chair.



TEM/BM
Black Shell with Black Mesh
and Black Nylon 5 Star Base.
Retail Price £418



TEM/WM
Black Shell with White Mesh
and Black Nylon 5 Star Base.
Retail Price £418



TEMW/BM
White Shell with Black Mesh
and Black Nylon 5 Star Base.
Retail Price £428



TEMW/WM
White Shell with White Mesh
and Black Nylon 5 Star Base.
Retail Price £428



TEM/BM/PB
Black Shell with Black Mesh and
Polished Aluminium 5 Star Base.
Retail Price £472



TEM/WM/PB
Black Shell with White Mesh and
Polished Aluminium 5 Star Base.
Retail Price £472



TEMW/BM/PB
White Shell with Black Mesh and
Polished Aluminium 5 Star Base.
Retail Price £482



TEMW/WM/PB
White Shell with White Mesh and
Polished Aluminium 5 Star Base.
Retail Price £482



TEM4S/BM/PB
White Shell with Black Mesh and
Polished Aluminium 4 Star Base.
Retail Price £484



TEM4S/WM
Black Shell with White Mesh and
Black Aluminium 4 Star Base.
Retail Price £486

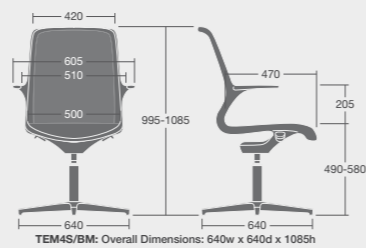
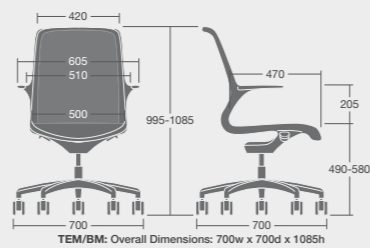

Loop Task Chair

Key Features

- Breathable black or grey mesh back.
- Donati weight activated synchronised mechanism.
- 18° backrest.
- 6° seat tilting angle.
- 3 locking positions.
- Soft upholstered lumbar support.
- Seat height adjustment.
- Seat slide option available.
- Choice of arm options available.
- Headrest option available.
- 670mm Black nylon five-star base as standard.
- Black tubular cantilever frame as standard.



LOO
Task Chair without Arms.
Black Nylon 5 Star Base
with Black Mesh.
Retail Price £379



LOO/GM/WH/3D
Task Chair with Arms.
White Metal 5 Star Base
with Grey Mesh.
Retail Price £535



LOO/PB/3DP
Task Chair with Arms.
Polished Aluminium 5 Star Base
with Grey Mesh.
Retail Price £558

- Black Nylon (Standard)
 - Polished Aluminium Add £54 (Retail)
 - White Metal Add £68 (Retail)
- 5 Star Base Finishes.



LOOC
Cantilever Meeting Chair without Arms.
Black Cantilever Frame.
Retail Price £349



LOOC/3D
Loop Cantilever Meeting Chair with Arms.
Black Cantilever Frame.
Retail Price £437

- Black Graphite (Standard)
 - Silver Add £0
 - White Add £0
- Cantilever Frame Finishes.

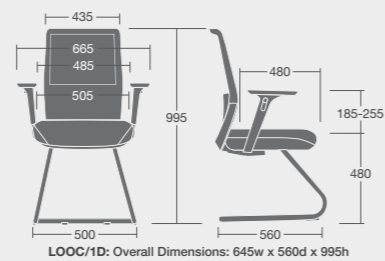
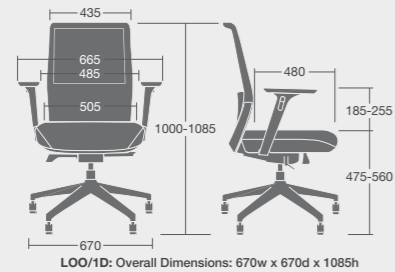

Vida Task Chair

Key Features

- Black mesh back.
- Height adjustable lumbar support.
- Weight responsive self-adjusting synchronised mechanism.
- Anti-shock locking system (4 positions).
- CMHR moulded seat foam.
- 50mm sliding seat depth adjustment.
- 670mm black nylon five-star base as standard.
- 60mm twin hard wheeled black castors on the task chair.
- 25mm black tubular cantilever frame as standard.
- Choice of 2 arm options available.



VID
Task Chair without Arms.
Black Nylon 5 Star Base.
Retail Price £351



VID/3D/PB
Task Chair with Arms.
Polished Aluminium 5 Star Base.
Retail Price £493

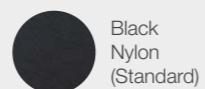

Black Nylon (Standard)

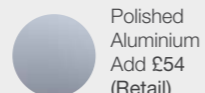

Polished Aluminium Add £54 (Retail)

5 Star Base Finishes.



VIDC
Cantilever Meeting Chair without Arms.
Black Cantilever Frame.
Retail Price £327



VIDC/1D/CF
Cantilever Meeting Chair with Arms.
Chrome Cantilever Frame.
Retail Price £416

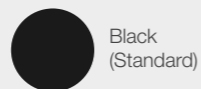

Black (Standard)

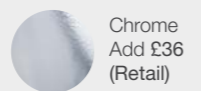

Chrome Add £36 (Retail)

Cantilever Frame Finishes.

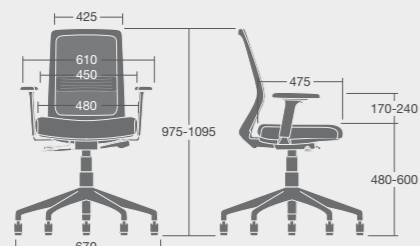

VID/1D: Overall Dimensions: 670w x 670d x 1095h

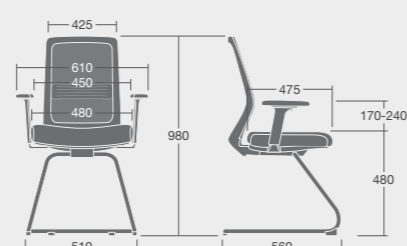

VIDC/1D: Overall Dimensions: 610w x 560d x 980h



Ace Multi-Purpose Chair

Key Features

- Designed by Claudio Bellini.
- Distinctive open lumbar design.
- Chairs with arms are supplied with a tilt mechanism.
- Available with a black or grey shell.
- Inner structure of back cushion fits closely to human body curve.
- Available with a 4 legged or a sled base.
- Available with a four-star or a five-star base.



ACEB
4 Legged Chair
Without Arms.
Retail Price £285



ACEG/GFA
4 Legged Chair
With Fixed Arms.
Retail Price £338



ACESBB
Sled Base Chair
Without Arms.
Retail Price £285



ACESBG/GFA
Sled Base Chair
With Fixed Arms.
Retail Price £338



ACE4SG
4-Star Swivel Base Chair
Without Arms.
Retail Price £389



ACE4SBA
4-Star Swivel Base Chair
With Fixed Arms.
Retail Price £445



ACE5SG
5-Star Swivel Base Chair
Without Arms.
Retail Price £375



ACE5SBA
5-Star Swivel Base Chair
With Fixed Arms.
Retail Price £429

4 Legged and Cantilever Sled Base Finishes

Standard Colours



Silver Add £0 Black Graphite Add £0 White Add £0

Premium Colours



Chrome Add £45 (Retail) Black Add £18 (Retail) Blue Add £18 (Retail) Coral Add £18 (Retail) Green Add £18 (Retail) Light Grey Add £18 (Retail) Teal Add £18 (Retail) Yellow Add £18 (Retail)

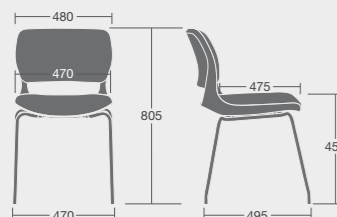

ACE: Overall Dimensions: 480w x 495d x 805h

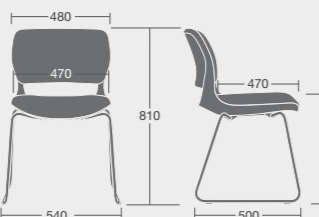

ACESB: Overall Dimensions: 540w x 500d x 810h

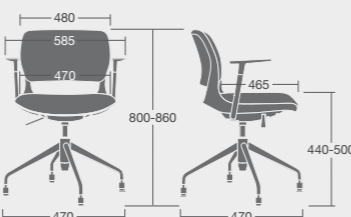

ACE4SBA: Overall Dimensions: 585w x 470d x 860h



ACE5SBA: Overall Dimensions: 585w x 470d x 955h



Pablo Chair

Key Features

- Fully upholstered.
- CMHR Foam.
- Steel four-legged frame available in 11 colour finishes.



PAB
Fully Upholstered Chair
without arms.
Retail Price £320



PABA
Fully Upholstered Chair
with arms.
Retail Price £365

Standard Colours

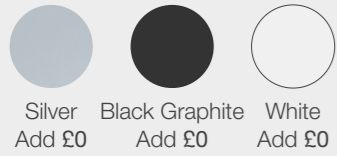

Silver Add £0 Black Graphite Add £0 White Add £0

Premium Colours



Chrome Effect Add £50 (Retail) Black Add £21 (Retail) Blue Add £21 (Retail) Coral Add £21 (Retail) Green Add £21 (Retail) Light Grey Add £21 (Retail) Teal Add £21 (Retail) Yellow Add £21 (Retail)

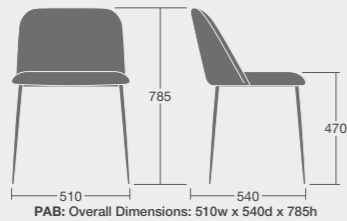

PAB: Overall Dimensions: 510w x 540d x 785h

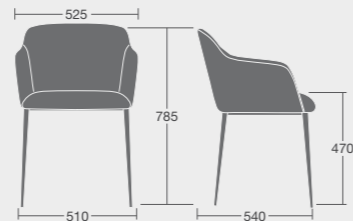

PABA: Overall Dimensions: 525w x 540d x 785h



Norden Multi-Purpose Chair

Key Features

- Fully upholstered.
- Injection moulded foam.
- Protective felt glides on 4 legged base.
- Black polypropylene base option.
- Wooden 4 legged base available in six colours.
- Two-tone upholstery available on shell.



NOR
Black Polypropylene
4 Legged Chair.
Retail Price £381



NORWL
Wooden
4 Legged Chair.
Retail Price £457

Wooden Frame Finishes

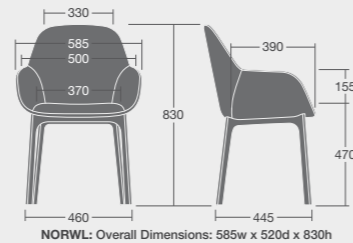
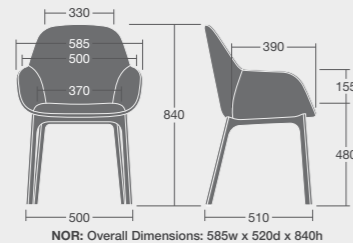
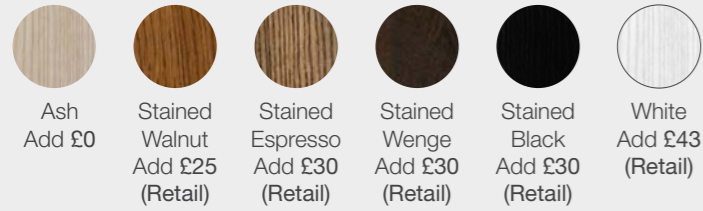

Luma Lounge Chair

Key Features

- Fully upholstered seat.
- Two-tone upholstery available on shell.
- Choice of three frames.
- Wooden frames available in six colours.
- Injected foam shell.



LUM
Lounge Chair with
Metal Pyramid Base.
Retail Price £639



LUMWL
Lounge Chair with
4 Legged Frame.
Retail Price £719



LUMSWWL
Lounge Chair with Swivel
Wooden Pyramid Base.
Retail Price £762

Wooden Frame Finishes

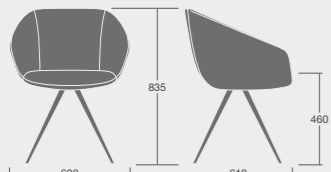
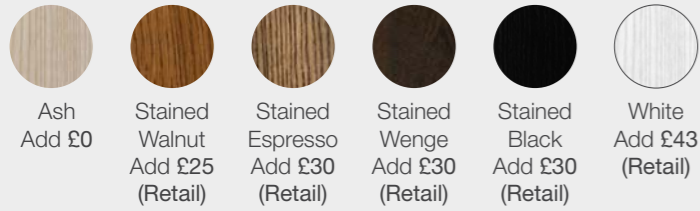

LUM: Overall Dimensions: 630w x 610d x 835h

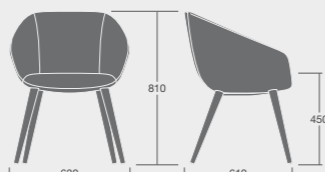

LUMWL: Overall Dimensions: 630w x 610d x 810h

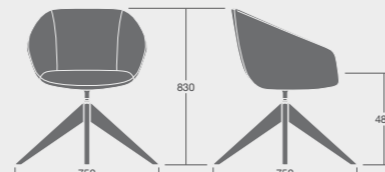

LUMSWWL: Overall Dimensions: 750w x 750d x 830h



Pedestals

Key Features

- 25mm Top Panels available in MFC or Veneer.

MFC: Ash, Autumn Cherry, Beech, Chester Oak, English Walnut, Grey, Grey Nebraska Oak, Laurentii Wenge, Natural Nebraska Oak and White.

Veneer: Oak and Walnut.

- Lockable, includes 2 x keys.
- Choice of handles available, see page 53.



Low Mobile Pedestal

MPF 2 Drawers. 418w x 600d x 480h.
1 x Single and 1 x Filing Drawer.

MP3 3 Drawers. 418w x 600d x 480h.
3 x Single Drawers.

Retail
MFC Retail
Veneer

£251 £392

£251 £392



Desk High Pedestal

DHP2/6 2 Drawers. 466w x 600d x 740h.
2 x Filing Drawers.

Retail
MFC Retail
Veneer

£337 £523



Desk High Pedestal

DHPF 3 Drawers. 418w x 600d x 740h.
2 x Single and 1 x Filing Drawer.

Retail
MFC Retail
Veneer

£337 £523

SDHPF 3 Drawers. 418w x 600d x 740h.
2 x Single and 1 x Filing System Drawer.

£398 £586

DHP4 4 Drawers. 418w x 600d x 740h.
4 x Single Drawers.

£337 £523

SDHP4 4 Drawers. 418w x 600d x 740h.
4 x Single System Drawers.

£398 £586



Low Mobile Pedestal on Castors

MPFM 2 x Drawers. 418w x 600d x 547h.
1 x Single and 1 x Filing Drawer.

Retail
MFC Retail
Veneer

£312 £452

MP3M 3 x Drawers. 418w x 600d x 547h.
3 x Single Drawers.

£312 £452



Deep Desk High Pedestal

DHP2/8 2 x Drawers. 466w x 800d x 740h.
2 x Filing Drawers.

Retail
MFC Retail
Veneer

£444 £686



Narrow Mobile Pedestal

DMPF/N 3 Drawers. 298w x 600d x 640h.
2 x Single and 1 x Filing Drawer.

Retail
MFC Retail
Veneer

£303 £472

SDMPF/N 3 Drawers. 298w x 600d x 640h.
2 x Single and 1 x Filing System Drawer.

£353 £551

DMP4/N 4 Drawers. 298w x 600d x 640h.
4 x Single Drawers.

£303 £472

SDMP4/N 4 Drawers. 298w x 600d x 640h.
4 x Single System Drawers.

£353 £551



Deep Desk High Pedestal

DHPF/8 3 x Drawers. 418w x 800d x 740h.
2 x Single and 1 x Filing Drawer.

Retail
MFC Retail
Veneer

£444 £686

SDHPF/8 3 x Drawers. 418w x 800d x 740h.
2 x Single and 1 x Filing System Drawer.

£502 £749

DHP4/8 4 x Drawers. 418w x 800d x 740h.
4 x Single Drawers.

£444 £686

SDHP4/8 4 x Drawers. 418w x 800d x 740h.
4 x Single System Drawers.

£502 £749



Mobile Pedestal

DMPF 3 Drawers. 418w x 600d x 640h.
2 x Single and 1 x Filing Drawer.

Retail
MFC Retail
Veneer

£320 £499

SDMPF 3 Drawers. 418w x 600d x 640h.
2 x Single and 1 x Filing System Drawer.

£380 £558

DMP4 4 Drawers. 418w x 600d x 640h.
4 x Single Drawers.

£320 £499

SDMP4 4 Drawers. 418w x 600d x 640h.
4 x Single System Drawers.

£380 £558



Open Fronted Pedestal-top Storage Unit

DHPSU/8 418w x 800d x 375h.

Retail
MFC Retail
Veneer

£195 £302

Steel Pedestals

Key Features

- Metalwork available in Silver RAL 9006 (standard), Black Graphite RAL 9004 and White RAL 9003.
- Lockable, includes 2 x keys.
- Supplied with pen tray.



3 Drawer Narrow Steel Flat Fronted Mobile Pedestal

			Retail Metalwork
DMSF/N/F	Silver RAL 9006.	300w x 520d x 600h.	£248
DMSF/N/FBG	Black Graphite RAL 9004.	300w x 520d x 600h.	£248
DMSF/N/FW	White RAL 9003.	300w x 520d x 600h.	£248

2 x Single and 1 x Filing Drawer.



3 Drawer Steel Flat Fronted Mobile Pedestal

			Retail Metalwork
DMSF/F	Silver RAL 9006.	390w x 520d x 600h.	£255
DMSF/FBG	Black Graphite RAL 9004.	390w x 520d x 600h.	£255
DMSF/FW	White RAL 9003.	390w x 520d x 600h.	£255

2 x Single and 1 x Filing Drawer.

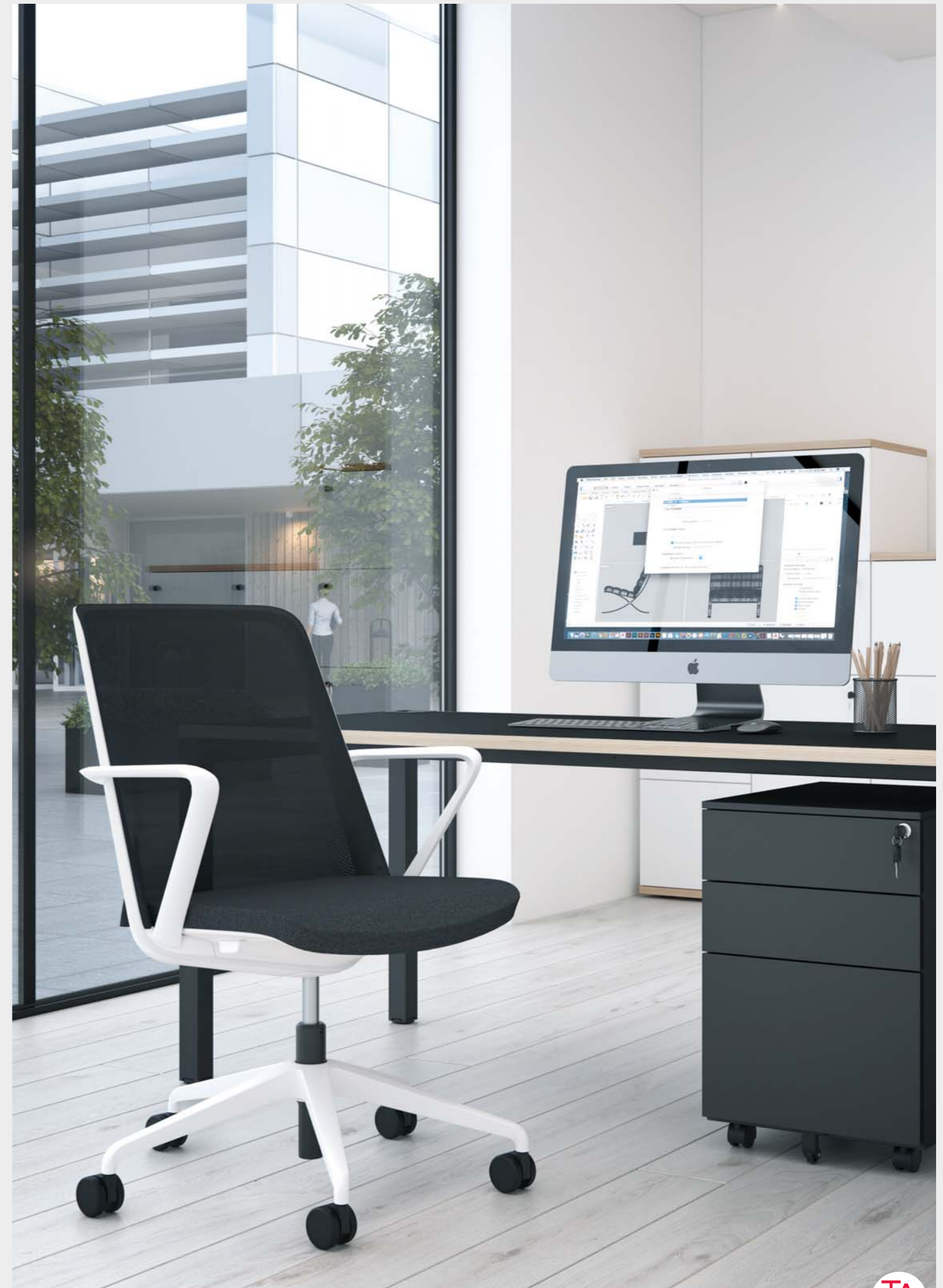

Storage Units

Key Features

- 25mm Top Panels available in MFC or Veneer.

MFC: Ash, Autumn Cherry, Beech, Chester Oak, English Walnut, Grey, Grey Nebraska Oak, Laurentii Wenge, Natural Nebraska Oak and White

Veneer: Oak and Walnut.

- Desk high storage lockable with 2 x keys where applicable.

- Choice of handles available, see page 53.



Desk High Storage Unit

			Retail MFC	Retail Veneer
NSU16/6	2 Adjustable shelves.	1600w x 600d x 740h.	£720	£1,118
NSU12/6	2 Adjustable shelves.	1200w x 600d x 740h.	£592	£917
NSU8/6	2 Adjustable shelves.	800w x 600d x 740h.	£466	£723
NSU16/5	1 Adjustable shelf.	1600w x 500d x 740h.	£657	£1,021
NSU12/5	1 Adjustable shelf.	1200w x 500d x 740h.	£539	£836
NSU8/5	1 Adjustable shelf.	800w x 500d x 740h.	£420	£653
NSU16/4	1 Adjustable shelf.	1600w x 400d x 740h.	£596	£955
NSU12/4	1 Adjustable shelf.	1200w x 400d x 740h.	£489	£788
NSU8/4	1 Adjustable shelf.	800w x 400d x 740h.	£379	£628



Open Fronted Desk High Storage Unit

			Retail MFC	Retail Veneer
NOSU12/6	1 Adjustable shelf.	1200w x 600d x 740h.	£494	£768
NOSU12/5	1 Adjustable shelf.	1200w x 500d x 740h.	£450	£697
NOSU12/4	1 Adjustable shelf.	1200w x 400d x 740h.	£401	£621



Open Fronted Desktop Storage Unit

			Retail MFC	Retail Veneer
TC12	1 Adjustable shelf.	1200w x 350d x 725h.	£299	£467
TC8	1 Adjustable shelf.	800w x 350d x 725h.	£233	£359

Suitable for Desk High Storage Unit and Open Fronted Desk High Storage Unit (see above)



Combined Storage Unit

			Retail MFC	Retail Veneer	
CSU7/6/D2	2 Doors	1 Adjustable shelf.	1000w x 600d x 740h.	£476	£737
CSU7/6/D3	3 Doors	2 Adjustable shelves.	1500w x 600d x 740h.	£714	£1,106
CSU7/6/D4	4 Doors	2 Adjustable shelves.	2000w x 600d x 740h.	£928	£1,437
CSU7/5/D2	2 Doors	1 Adjustable shelf.	1000w x 500d x 740h.	£442	£683
CSU7/5/D3	3 Doors	2 Adjustable shelves.	1500w x 500d x 740h.	£663	£1,025
CSU7/5/D4	4 Doors	2 Adjustable shelves.	2000w x 500d x 740h.	£862	£1,332



Storage Unit

Storage Unit			Retail MFC	Retail Veneer
NSSC10	1 Adjustable shelf.	1060w x 500d x 740h.	£542	£837



Glass Fronted Desktop Storage Unit with Hinged Doors

			Retail MFC	Retail Veneer
TCGH	1 Adjustable shelf.	1060w x 350d x 875h.	£559	£864

Suitable for NSSC10 (see above)



Filing Cabinet

			Retail MFC	Retail Veneer
FC4	4 Filing Drawers.	466w x 600d x 1398h.	£516	£855
FC3	3 Filing Drawers.	466w x 600d x 1069h.	£436	£716
FC2	2 Filing Drawers.	466w x 600d x 740h.	£347	£573



Bookcases

Key Features

- 18mm Top, Back and Shelf Panels available in MFC or Veneer.

MFC: Ash, Autumn Cherry, Beech, Chester Oak, English Walnut, Grey, Grey Nebraska Oak, Laurentii Wenge, Natural Nebraska Oak and White.

Veneer: Oak and Walnut.

- Delivered flat packed.
- Shelves available (see below).



Bookcase

Bookcase			Retail MFC	Retail Veneer
BS20	5 Adjustable shelves.	800w x 300d x 2000h.	£393	£611
BS18	4 Adjustable shelves.	800w x 300d x 1800h.	£321	£501
BS16	4 Adjustable shelves.	800w x 300d x 1600h.	£307	£477
BS12	3 Adjustable shelves.	800w x 300d x 1200h.	£287	£445
BS10	2 Adjustable shelves.	800w x 300d x 1000h.	£236	£374
BS7	1 Adjustable shelf.	800w x 300d x 740h.	£212	£332



Adjustable Shelf

Adjustable Shelf		Retail MFC	Retail Veneer
BS	764w x 278d x 18h.	£32	£52



Storage Units

Key Features

- 25mm Top Panels available in MFC or Veneer.

MFC: Ash, Autumn Cherry, Beech, Chester Oak, English Walnut, Grey, Grey Nebraska Oak, Laurentii Wenge, Natural Nebraska Oak and White.

Veneer: Oak and Walnut.

- 2 x Hinged doors.
- Lockable, includes 2 x keys.
- Choice of handles available, see page 53.
- System storage units (NSSC) supplied as carcass only.
- Shelves available (see below).



Storage Unit				Retail MFC	Retail Veneer
SC20	18mm Top	4 Adjustable shelves.	800w x 400d x 2000h.	£643	£999
SC18	18mm Top	3 Adjustable shelves.	800w x 400d x 1800h.	£579	£900
SC16	18mm Top	3 Adjustable shelves.	800w x 400d x 1600h.	£516	£799
SC12	18mm Top	2 Adjustable shelves.	800w x 400d x 1200h.	£452	£700
SC7	25mm Top	1 Adjustable shelf.	800w x 400d x 740h.	£379	£587

System Storage Unit			Retail MFC	Retail Veneer
Supplied without shelves (see below)				
NSSC20	990w x 500d x 2000h.		£718	£1,109
NSSC18	990w x 500d x 1800h.		£648	£1,003
NSSC16	990w x 500d x 1600h.		£581	£906
NSSC12	990w x 500d x 1200h.		£518	£804
NSSC7	990w x 500d x 740h.		£455	£703
NSSC7/6	990w x 600d x 740h.		£490	£759

Adjustable Shelves			Retail MFC	Retail Veneer
BS	For SC12-SC20 Units.	764w x 278d x 18h.	£32	£52
SC7/S	For SC7 Units.	760w x 276d x 18h.	£32	£52
NSSC	For 500d NSSC Units.	950w x 408d x 18h.	£35	£56
NSSC7/6S	For 600d NSSC7/6 Units.	950w x 500d x 18h.	£39	£60



Cubeform

Key Features

- 18mm panels supplied in MFC.

MFC: Ash, Autumn Cherry, Beech, Chester Oak, English Walnut, Grey, Grey Nebraska Oak, Laurentii Wenge, Natural Nebraska Oak and White.

- Metalwork finishes available in:

Standard: Silver RAL 9006 (standard), Black Graphite RAL 9004, White RAL 9003 and Raw Finish (Add 5%).

Premium: Blue RAL 5001, Coral RAL 2001, Green RAL 6016, Light Grey RAL 7038, Teal RAL 5018 and Yellow RAL 1021 (Add 12% for all - 2 Week Lead Time).



Cubeform

For configuration as shown.
Cubeform 1 925w x 400d x 930h.

Retail Price

£710



Cubeform

For configuration as shown.
Cubeform 2 925w x 400d x 1380h.

Retail Price

£934



Cubeform

For configuration as shown.
Cubeform 3 925w x 400d x 1830h.

Retail Price

£1,158



Cubeform

For configuration as shown.
Cubeform 4 925w x 400d x 2280h.

Retail Price

£1,382



Cubeform

For configuration as shown.
Cubeform 5 850w x 850d x 1380h.

Retail Price

£1,127



Cubeform

For configuration as shown.
Cubeform 6 1300w x 1750d x 1830h.

Retail Price

£2,567



Cubeform Accessories

Key Features

- 18mm panels supplied in MFC.

MFC: Ash, Autumn Cherry, Beech, Chester Oak, English Walnut, Grey, Grey Nebraska Oak, Laurentii Wenge, Natural Nebraska Oak and White.

Optional MFC: Paraline, Petrol, Red, Sea Blue, Turquoise and Yellow (available on Door Fronts, Drawer Fronts and Planter Boxes Only).

- Metalwork finishes available in:

Standard: Silver RAL 9006 (standard), Black Graphite RAL 9004, White RAL 9003 and Raw finish (Add 5%).

Premium: Blue RAL 5001, Coral RAL 2001, Green RAL 6016, Light Grey RAL 7038, Teal RAL 5018 and Yellow RAL 1021 (Add 12% for all - 2 Week Lead Time).



Cubeform Single Door Box

- Can be specified on standard shelves only (not corner shelves).
- Available with Standard, Combination or Digital Keypad Lock.
- Available with Standard, Whiteboard or Fabric back.

- For Standard Key Lock, use standard code
- For Combination Lock, add £21 and suffix /CL
- For Digital Keypad Lock, add £57 and suffix /DKL

			Retail MFC	Optional MFC on Door Fronts (Retail)
CF/SDB	Standard Back	423w x 396d x 423h.	£215	£253
CF/SDB/WB	Whiteboard Back	423w x 396d x 423h.	£280	£318
CF/SDB/FB	Fabric Back	423w x 396d x 423h.	£280	£318

Cubeform Single Planter Box



- Planter boxes can be used on standard shelves only (not corner shelves).
- 387w x 360d x 152h internal dimensions.
- This unit is supplied without plants, plant tray or liner.
- The units require a waterproof membrane liner to protect against moisture and water ingress.

			Retail MFC	Optional MFC (Retail)
CF/SPB	423w x 396d x 170h.		£150	£188



Cubeform 1 Drawer Unit

- Can be specified on standard shelves only (not corner shelves).
- Available with Standard, Whiteboard or Fabric back.
- Lockable, includes 2 x keys.
- Choice of handle suites available, see page 53.

			Retail MFC	Optional MFC on Drawer Fronts (Retail)
CF/DU1	Standard Back	423w x 396d x 423h.	£245	£283
CF/DU1/WB	Whiteboard Back	423w x 396d x 423h.	£310	£348
CF/DU1/FB	Fabric Back	423w x 396d x 423h.	£310	£348

Cubeform Double Planter Box



- Planter boxes can be used on standard shelves only (not corner shelves).
- Double planter boxes require space 2 shelves.
- 864w x 312d x 152h internal dimensions.
- This unit is supplied without plants, plant tray or liner.
- The units require a waterproof membrane liner to protect against moisture and water ingress.

			Retail MFC	Optional MFC (Retail)
CF/DPB	900w x 348d x 170h.		£200	£250



Cubeform 2 Drawer Unit

- Can be specified on standard shelves only (not corner shelves).
- Available with Standard, Whiteboard or Fabric back.
- Lockable, includes 2 x keys.
- Choice of handle suites available, see page 53.

			Retail MFC	Optional MFC on Drawer Fronts (Retail)
CF/DU2	Standard Back	423w x 396d x 423h.	£245	£283
CF/DU2/WB	Whiteboard Back	423w x 396d x 423h.	£310	£348
CF/DU2/FB	Fabric Back	423w x 396d x 423h.	£310	£348

Cubeform Open Fronted Box



- Can be specified on standard shelves only (not corner shelves).
- Available with Standard, Whiteboard or Fabric back.

			Retail Price
CF/OFB	Standard Back	423w x 396d x 423h.	£175
CF/OFB/WB	Whiteboard Back	423w x 396d x 423h.	£240
CF/OFB/FB	Fabric Back	423w x 396d x 423h.	£240

Cubeform Optional MFC Finishes (For Door Fronts, Drawer Fronts and Planter Boxes Only)

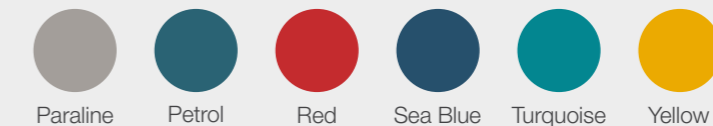

Cubeform Premium Metalwork Finishes

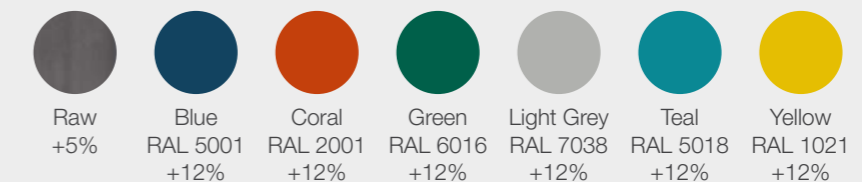

Handles

Key Features

- Metalwork available in Silver RAL 9006 (standard), Black Graphite RAL 9004 and White RAL 9003.

Standard Metal Handle

- 160mm centres. • Supplied as standard on all items requiring handles.

			Retail Metalwork
Silver RAL 9006.	168w x 10d x 25h.		£0
Black Graphite RAL 9004.	168w x 10d x 25h.		£0
White RAL 9003.	168w x 10d x 25h.		£0

Metal Handle

- 160mm centres.

			Retail Metalwork
STD	Silver RAL 9006.	168w x 10d x 25h.	£5
STD/BG	Black Graphite RAL 9004.	168w x 10d x 25h.	£5
STD/W	White RAL 9003.	168w x 10d x 25h.	£5

Metal Bridge Handle

- 128mm centres. • Not retrofittable.

			Retail Metalwork
BRG	Silver RAL 9006.	140w x 10d x 25h.	£5
BRG/BG	Black Graphite RAL 9004.	140w x 10d x 25h.	£5
BRG/W	White RAL 9003.	140w x 10d x 25h.	£5

Metal Camber Handle

- 128mm centres. • Not retrofittable.

			Retail Metalwork
CAM	Silver RAL 9006.	155w x 5d x 25h.	£5
CAM/BG	Black Graphite RAL 9004.	155w x 5d x 25h.	£5
CAM/W	White RAL 9003.	155w x 5d x 25h.	£5

Metal T-Bar Handle

- 128mm centres. • Not retrofittable.

			Retail Metalwork
BAR	Silver RAL 9006.	168w x 10d x 34h.	£5
BAR/BG	Black Graphite RAL 9004.	168w x 10d x 34h.	£5
BAR/W	White RAL 9003.	168w x 10d x 34h.	£5

Metal Slab Handle

- 128mm centres. • Not retrofittable.

			Retail Metalwork
SLB	Silver RAL 9006.	188w x 10d x 30h.	£5
SLB/BG	Black Graphite RAL 9004.	188w x 10d x 30h.	£5
SLB/W	White RAL 9003.	188w x 10d x 30h.	£5

Metal Bow Handle

- 128mm centres. • Not retrofittable.

			Retail Metalwork
BOW	Silver RAL 9006.	160w x 8d x 26h.	£5
BOW/BG	Black Graphite RAL 9004.	160w x 8d x 26h.	£5
BOW/W	White RAL 9003.	160w x 8d x 26h.	£5





Prime Power and Media Module

- 2 x 3.15amp individually fused sockets. • 1 x USB twin charger (type A+A).
- 200mm power and connection lead to 3 pole connector. • Fixing via 225w x 60dmm aperture.
- Requires a separate mains lead if connecting directly into a socket.
- Silver Body with Black Inserts, Black Body with Black Inserts or Matt White Body with Black Inserts.

			Retail Price
POW/PRI/2P1T/S	Silver	2 x Power, 1 x USB Twin Charger.	£219
POW/PRI/2P1T/B	Black	2 x Power, 1 x USB Twin Charger.	£219
POW/PRI/2P1T/W	White	2 x Power, 1 x USB Twin Charger.	£219

Prime Power and Media Module with Cover



- 2 x 3.15amp individually fused sockets. • 1 x USB twin charger (type A+A).
- 200mm power and connection lead to 3 pole connector. • Fixing via 225w x 60d aperture.
- Casing provided to discretely protect cables and sockets.
- Requires a separate mains lead if connecting directly into a socket.
- Silver Body with Black Inserts, Black Body with Black Inserts or Matt White Body with Black Inserts.

			Retail Price
POW/PRI/2P1T/C/S	Silver	2 x Power, 1 x USB Twin Charger.	£312
POW/PRI/2P1T/C/B	Black	2 x Power, 1 x USB Twin Charger.	£312
POW/PRI/2P1T/C/W	White	2 x Power, 1 x USB Twin Charger.	£312

Kaspa Power and Media Module



- 1 x or 2 x 3.15amp individually fused sockets. • 1 x USB twin charger (type A+A).
- Integral colour coded fuse clips. • 200mm power and connection lead to 3 pole connector.
- Fixing via 135w x 53dmm aperture (2 gang) or 189w x 53dmm (4 gang).
- Requires a separate mains lead if connecting directly into a socket
- Silver Body with Black Inserts, Black Body with Black Inserts or Matt White Body with Black Inserts.

			Retail Price
POW/KAS/1P1T/S	Silver	1 x Power, 1 x USB Twin Charger.	£183
POW/KAS/1P1T/B	Black	1 x Power, 1 x USB Twin Charger.	£183
POW/KAS/1P1T/W	White	1 x Power, 1 x USB Twin Charger.	£183
POW/KAS/2P1T/S	Silver	2 x Power, 1 x USB Twin Charger.	£204
POW/KAS/2P1T/B	Black	2 x Power, 1 x USB Twin Charger.	£204
POW/KAS/2P1T/W	White	2 x Power, 1 x USB Twin Charger.	£204

Port Hole Power and Media Module



- 1 x 3.15amp individually fused socket. • 1 x USB twin charger (type A+A).
- 1m connection lead. • Fixing via 80w porthole aperture.
- Grey Body, Black Body or White Body.

			Retail Price
PHPM/G	Grey	1 x Power, 1 x USB Twin Charger.	£198
PHPM/B	Black	1 x Power, 1 x USB Twin Charger.	£198
PHPM/W	White	1 x Power, 1 x USB Twin Charger.	£198

Capsule Desktop Power and Media Module



- 2 x 3amp switched sockets with resettable thermal fuses. • 1 x USB twin charger (type A+C).
- 2 x data blanks. • Cables exit from unit back. • Requires a separate mains lead if connecting directly into a socket. • Black Finish or White Finish.

			Retail Price
CAP/2P/B	Black	2 x Power, 1 x USB Twin Charger, 2 x Blanks.	£152
CAP/2P/W	White	2 x Power, 1 x USB Twin Charger, 2 x Blanks.	£152



Flex Desktop Power Module

- 2 x 3.15amp individually fused sockets. • Power and connection lead to 3 pole connector.
- Cables exit from unit back. • Requires a separate mains lead if connecting directly into a socket. • Grey Aluminium Body and Grey Plastic Ends, Black Plastic Body and Ends or White Plastic Body and Ends.

			Retail Price
FDT/2P/G	Grey	2 x Power.	£67
FDT/2P/B	Black	2 x Power.	£65
FDT/2P/W	White	2 x Power.	£65



Flex Desktop Power and Media Module

- 1 or 2 x 3.15amp individually fused sockets. • 1 x USB twin charger (type A+C)
- Power and connection lead to 3 pole connector. • Cables exit from unit back.
- Requires a separate mains lead if connecting directly into a socket.
- Grey Aluminium Body and Grey Plastic Ends, Black Plastic Body and Ends or White Plastic Body and Ends.

			Retail Price
FDT/1P/2USB/G	Grey	1 x Power, 1 x USB Twin Charger.	£152
FDT/1P/2USB/B	Black	1 x Power, 1 x USB Twin Charger.	£145
FDT/1P/2USB/W	White	1 x Power, 1 x USB Twin Charger.	£145



			Retail Price
FDT/2P/2USB/G	Grey	2 x Power, 1 x USB Twin Charger.	£168
FDT/2P/2USB/B	Black	2 x Power, 1 x USB Twin Charger.	£162
FDT/2P/2USB/W	White	2 x Power, 1 x USB Twin Charger.	£162

Wireless Charging Unit



- Charge smartphones and tablets wirelessly.
- Charging unit complete with USB power plug. • Fixing via 80w porthole aperture.
- Black Body and Trim, Black Body and Aluminium Trim, White Body and Trim, White Body and Aluminium Trim, Black Glass or White Glass.

		Retail Price
WCU/BB	Black.	£198
WCU/WW	White.	£198

WCU/AB	Aluminium / Black.	£230
WCU/AW	Aluminium / White.	£230

WCU/BG	Black Glass.	£211
WCU/WG	White Glass.	£211

Wireless Charging Receiver



- Charge smartphones and tablets wirelessly.
- Wireless Charging Unit required to support wireless charging.

WCU/WCR	Retail Price	£100
---------	--------------	------

Supa Lamp



- 7 watt power consumption. • 14%-100% dimming range.
- Desk base mounted. • 10 year, 24/7 warranty.

LGT/SUP/BM/G	Grey.
LGT/SUP/BM/B	Black.
LGT/SUP/BM/W	White.

Retail Price

£558
£558
£558

Mini Z-Bar Lamp



- Desk base mounted.
- 1 year warranty.

ZBARS	Silver.
ZBARB	Black.
ZBARW	White.

Retail Price

£348
£348
£348

Mini Z-Bar Aircharge Lamp



- Charge smartphones and tablets wirelessly. • In-built wireless charger.
- Desk base mounted. • 1 year warranty.

ZBAR/WCUS	Silver.
ZBAR/WCUB	Black.
ZBAR/WCUW	White.

Retail Price

£436
£436
£436

Slinky Cable Riser

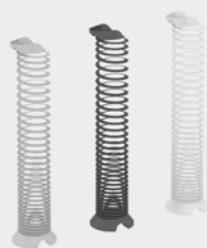

- Suitable for all desking ranges.

SCR/S	Silver.
SCR/B	Black.
SCR/W	White.

Retail Price

£50
£50
£50

CPU Holder



- Adjustable CPU holder for PC towers.
- Rotates a full 360 degrees for complete access to cables and ports.

CPU	Black		76-254w x 305-508h.	£141
CPUW	White		76-254w x 305-508h.	£141

PPCPU	Black	Progress Plus	76-254w x 305-508h.	£141
PPCPU/W	White	Progress Plus	76-254w x 305-508h.	£141

LUXCPU	Black	Lux	76-254w x 305-508h.	£162
CLUCPU/W	White	Lux	76-254w x 305-508h.	£162

MBCPU	Black	Matrix	76-254w x 305-508h.	£156
MBCPU/W	White	Matrix	76-254w x 305-508h.	£156

Retail Price

Desktop Mat



- Heavy duty black polyurethane with 90 degree lipped edge.

DTM	635w x 465d x 20h.
------------	--------------------

Retail Price

£131



Finishes

Dual Board MFC Finishes

- The 10 finishes below are our standard 25mm and 18mm MFC finishes.

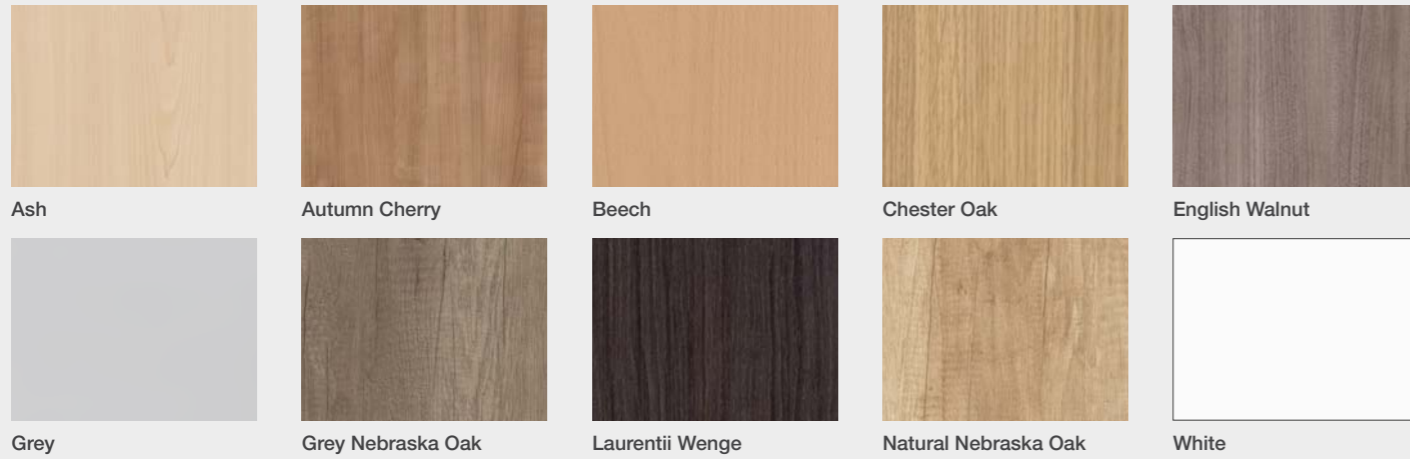

Standard Edging for White Dual Board MFC Finish

- The 3 finishes below are standard edging options for 25mm white Dual Board MFC only.
- Add £26 retail per top for Black or Laurentii Wenge edging and add £36 retail per top for Plywood edging.

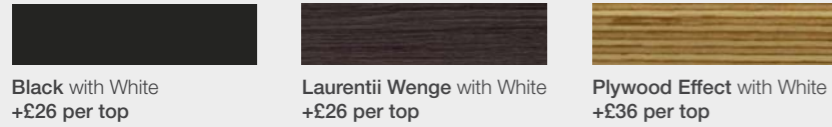

Nanotech Surface Finish

- The finish below is our Nanotech finish that can be specified on 25mm board only and is subject to a two week lead time.
- Undercut edging detail option available.
- Contact Customer Services for specification, prices and lead time.

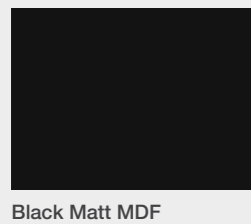

Standard Veneer Finishes

- The 2 finishes below are our standard 25mm and 18mm Veneer finishes.
- Elite process pre-veneered boards that cannot be book or colour matched and cannot guarantee continuity in the appearance of Veneer panels.

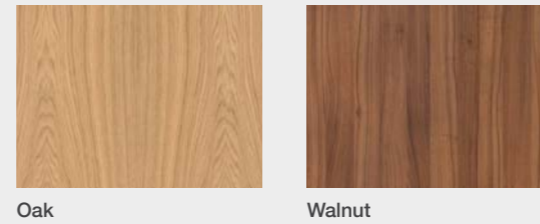

Cubeform Optional MFC Finishes

- The 6 finishes below are non-standard 18mm MFC finishes that can be specified on Cubeform doors, drawer fronts and planter boxes only.
- Matching edging tape.
- Subject to a 3 week lead time.



Lux, Norden and Luma Wooden Frame Finishes

- The 6 finishes below are available on Lux, Norden and Luma where wooden frames are specified.
- Due to the staining process and the use of natural materials, no guarantee can be given to the final appearance and continuity when staining timber products.

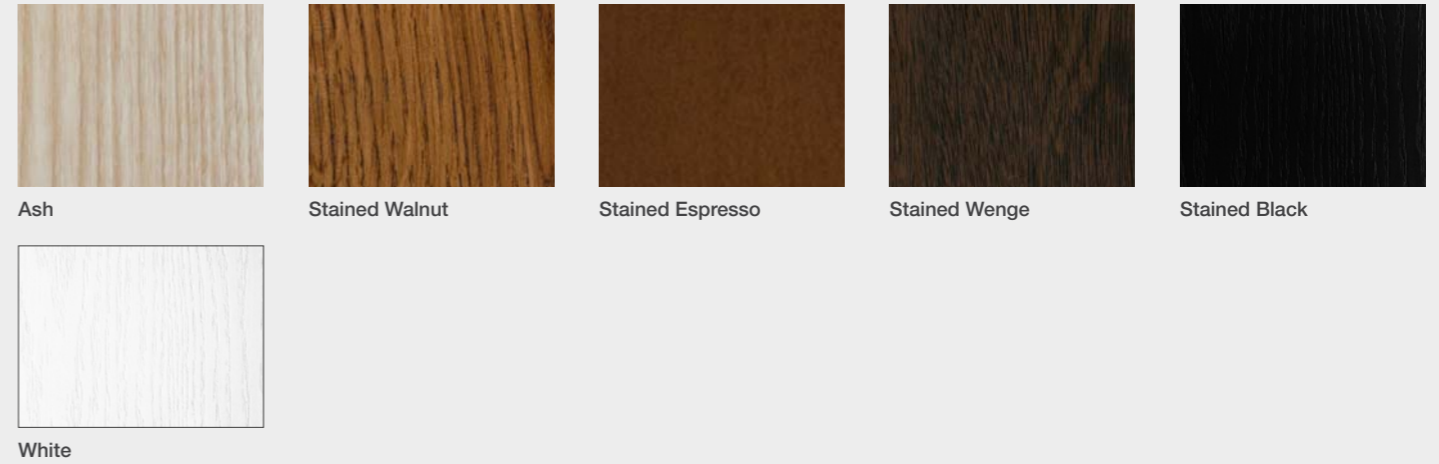

Standard Metalwork Finishes

- The 4 finishes below are our standard Metalwork finishes.

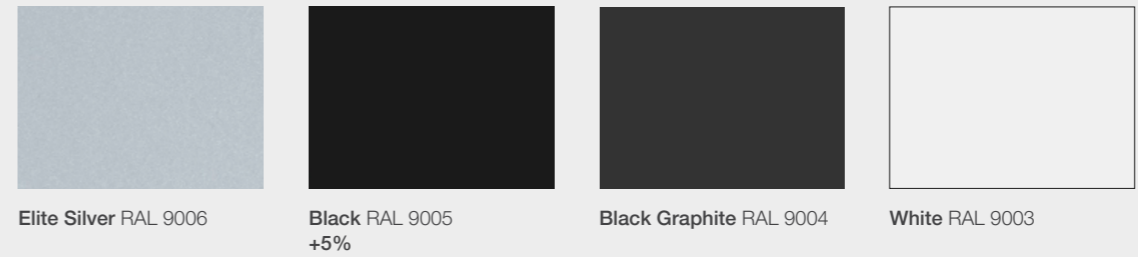

Item Specific Metalwork Finishes

- The 8 finishes below are non-standard Metalwork finishes which can be specified where indicated.
- Add 15% to retail price for Chrome Effect finish and add 5% to retail price for Raw Metalwork finish.
- Add 12% to retail price for Blue, Coral, Green, Light Grey, Teal and Yellow finishes and is subject to a two week lead time.

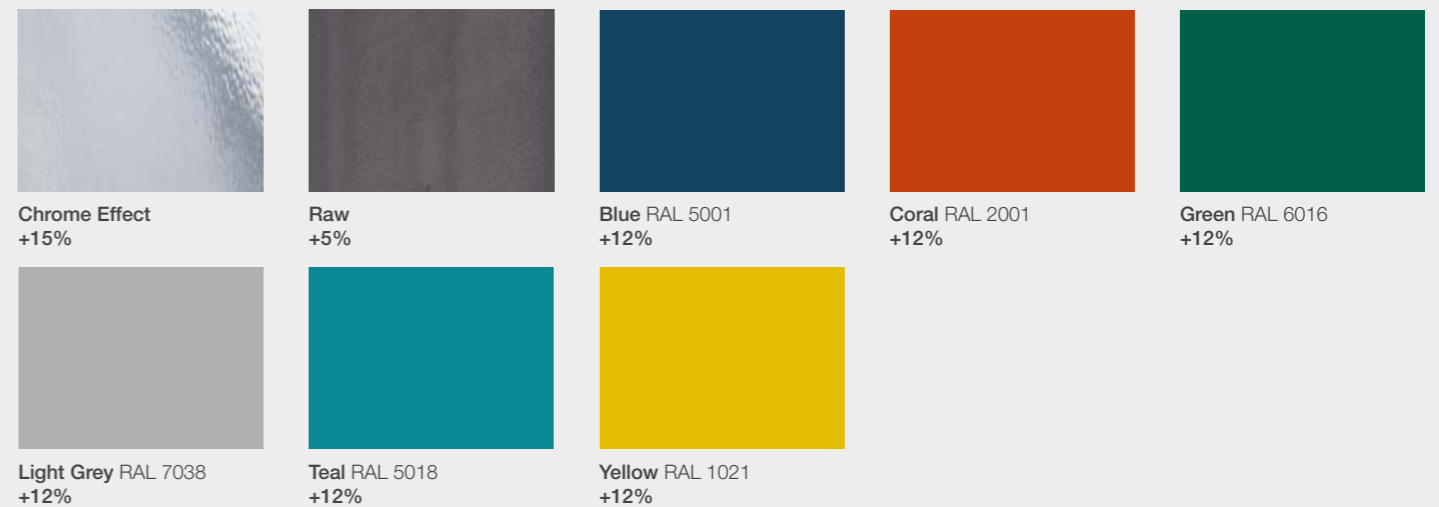

Fabrics

Camira Era Group 1 Fabric Finishes



Calendar CSE19



Occurrence CSE23



Date CSE24



Sequence CSE25



Generation CSE02

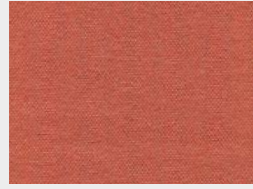

Turn CSE26

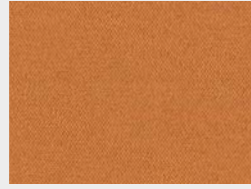

Measure CSE27



Span CSE05



Cycle CSE06



Phase CSE17



Experience CSE29



Extent CSE28



Prime CSE09



History CSE21



Futurist CSE01



Transition CSE30



Splitsecond CSE31



Lifetime CSE03



Occasion CSE32



Analogue CSE33



Endurance CSE34



Notation CSE36



Period CSE07



Timelapse CSE16

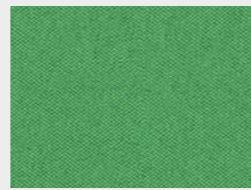

Event CSE18



Signature CSE35



Rest CSE37



Aeon CSE20



Everlasting CSE10



Stage CSE15



Maturity CSE40



Perennial CSE12



Range CSE42

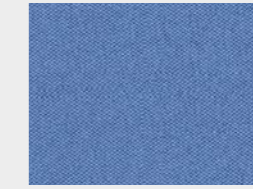

Chapter CSE08



Youth CSE39



Allowance CSE38



Memo CSE46



Quota CSE41



Prompt CSE45



Forecast CSE11



Late CSE43



Elapse CSE44



Present CSE13

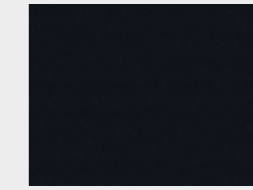

Forward CSE14

